

TRIPOD EASEL SIMPLEX CLIP ON

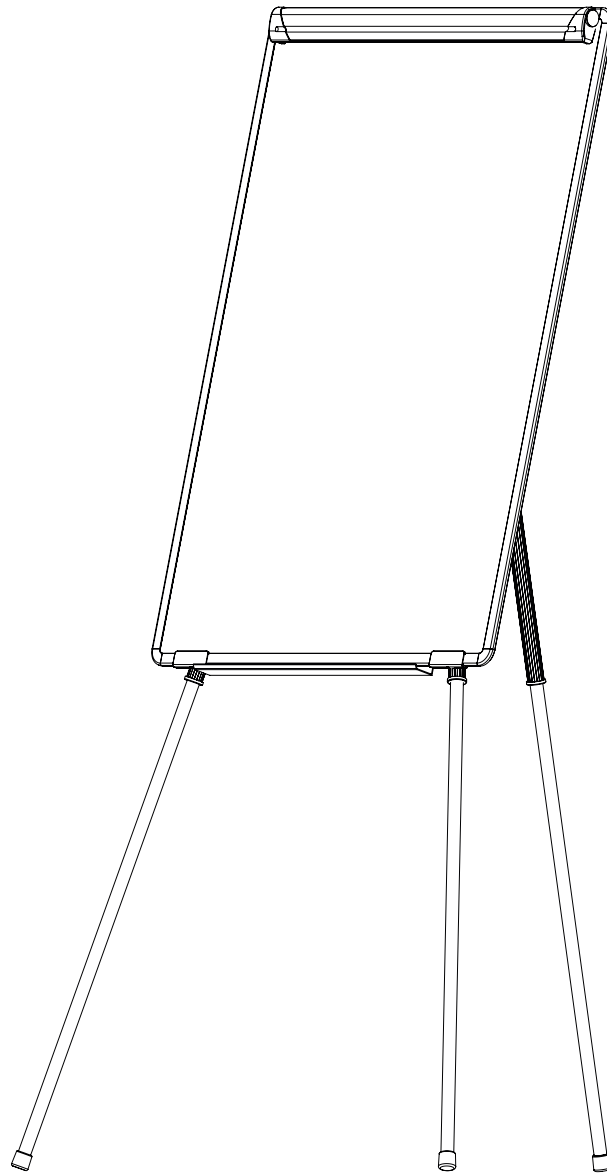







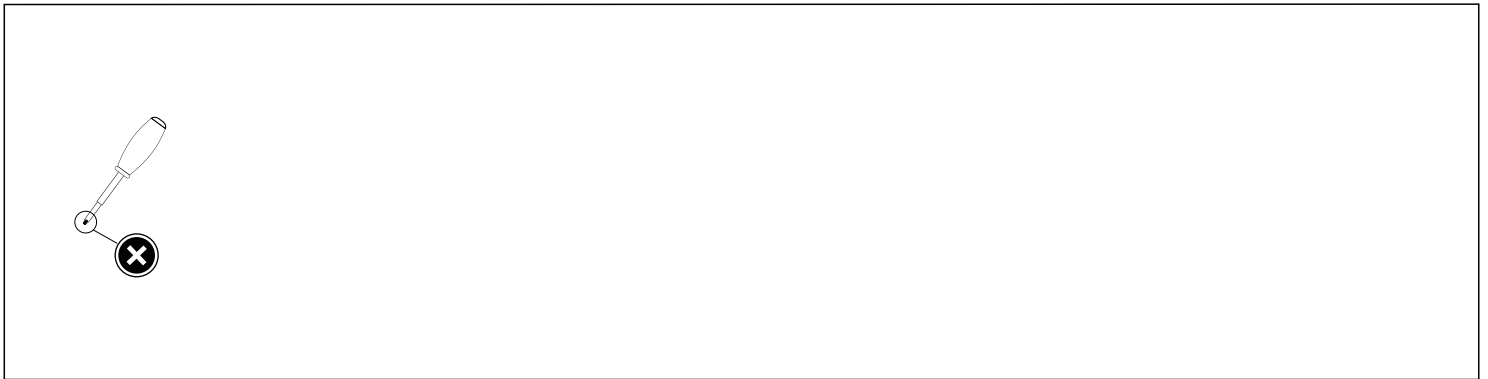



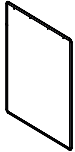
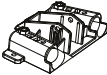



INSTRUCTIONS • INSTRUCTIES • ISTRUZIONI • ANLEITUNG • INSTRUCCIONES • INSTRUÇÕES



TRIPOD EASEL SIMPLEX CLIP ON

INSTRUCTIONS • INSTRUCTIES • ISTRUZIONI • ANLEITUNG • INSTRUCCIONES • INSTRUÇÕES

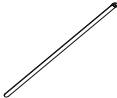

A.2x 	B.2x 	C.2x 	D.1x 	E.1x 	F.2x 
G.1x 	H.1x 	I.2x 	J.1x 	K.1x 	L.1x 
M.1x 	N.1x 	O.2x 	P.1x 	Q.2x 	R.2x 
S.2x 					

WITH EXTENDABLE ARMS



TRIPOD EASEL SIMPLEX CLIP ON

INSTRUCTIONS • INSTRUCTIES • ISTRUZIONI • ANLEITUNG • INSTRUCCIONES • INSTRUÇÕES

1

2x.A.
2x.B.

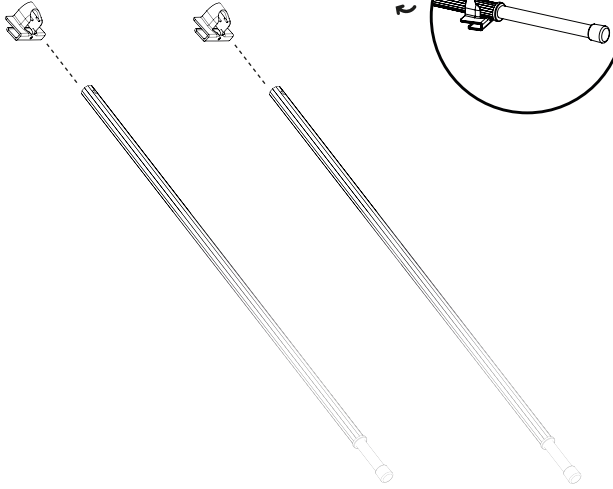

2

2x.C
1xD.
1xE.
2xF.
1xG.
1xH.

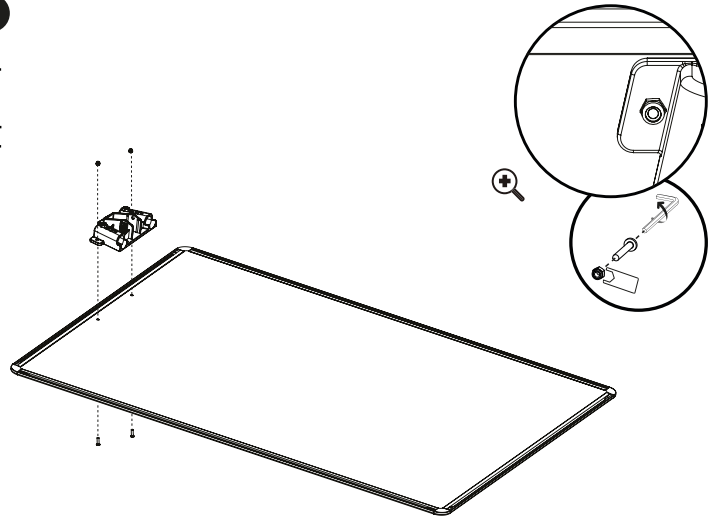

3

2x.I.

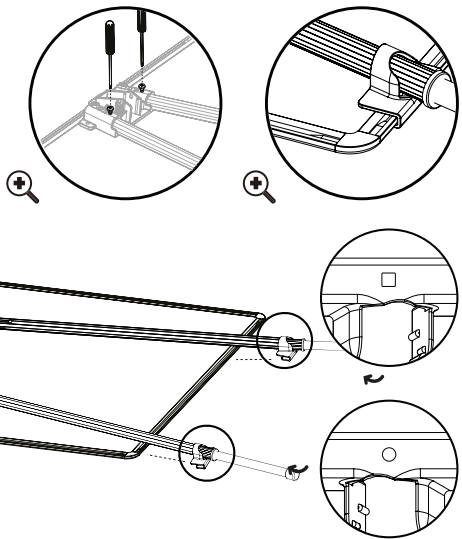

4

1xJ.
1xK.

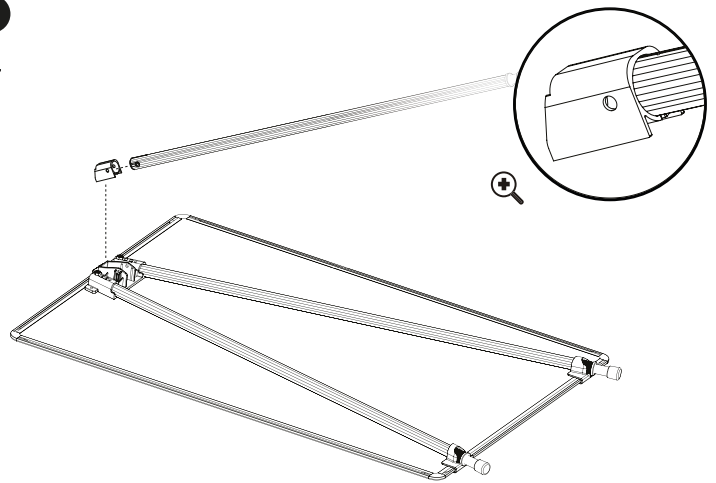

5

1xL.
1xM.

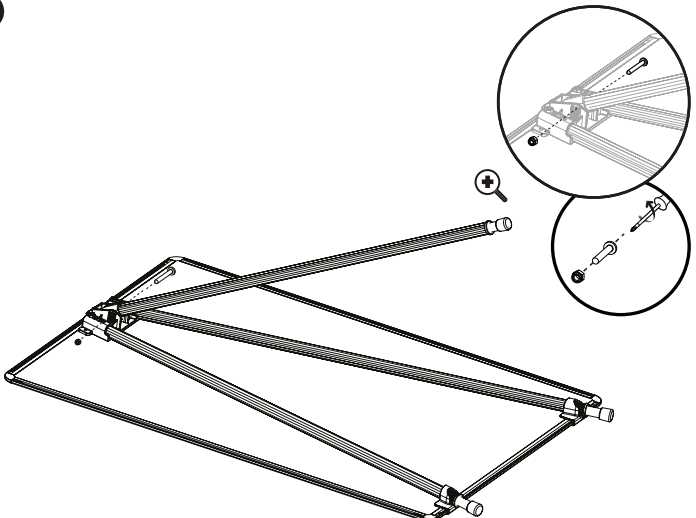

6

1xN.

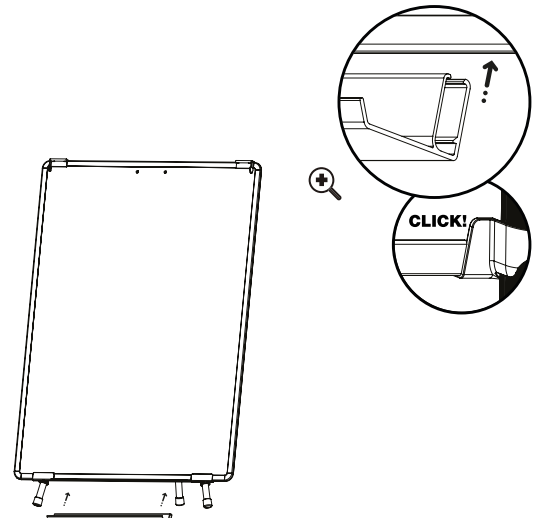

A.2x 	B.2x 	C.2x 	D.1x 	E.1x 	F.2x 	G.1x 	H.1x 	I.2x 	J.1x 	1001380290810_REV02	
K.1x 	L.1x 	M.1x 	N.1x 	O.2x 	P.1x 	Q.2x 	R.2x 	S.2x 			

WITH EXTENSIBLE ARMS

TRIPOD EASEL SIMPLEX CLIP ON

INSTRUCTIONS • INSTRUCTIES • ISTRUZIONI • ANLEITUNG • INSTRUCCIONES • INSTRUÇÕES

WITHOUT EXTENDABLE ARMS

7
2x.O.

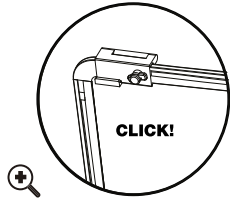
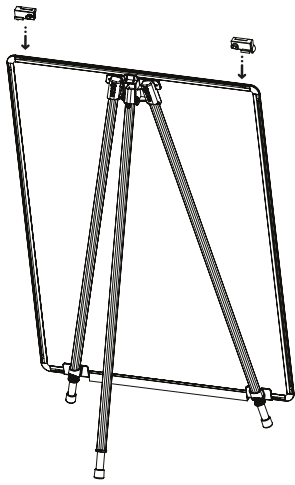

8
1xP
2x.Q
2x.R.

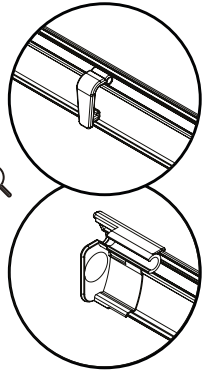
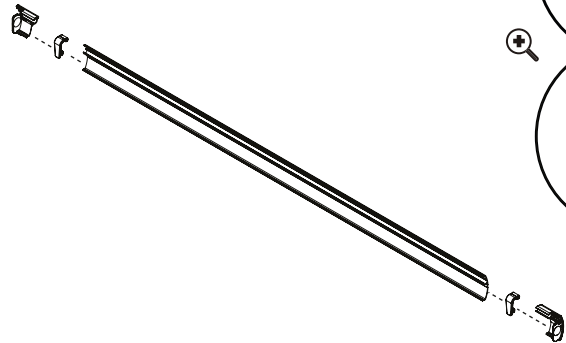

9

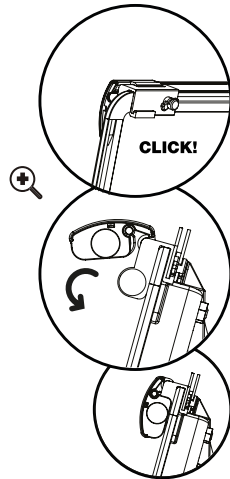
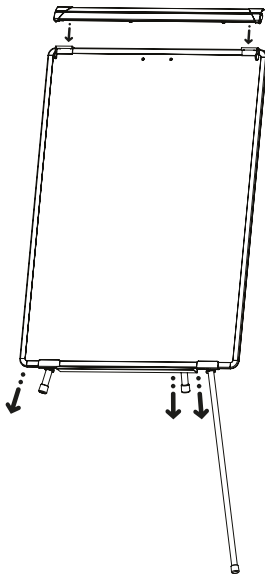

7
2x.O.
2x.S.

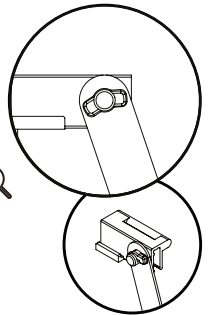
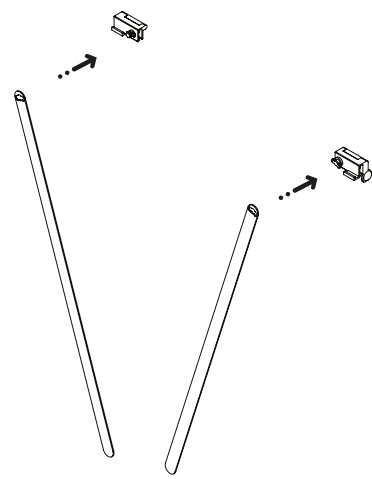

8

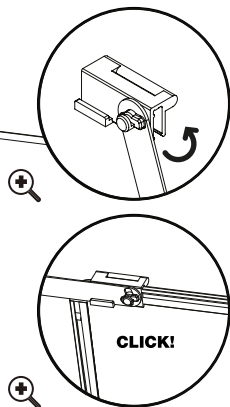
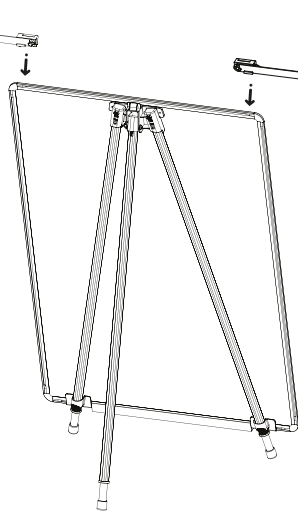

9

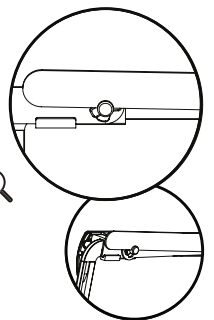
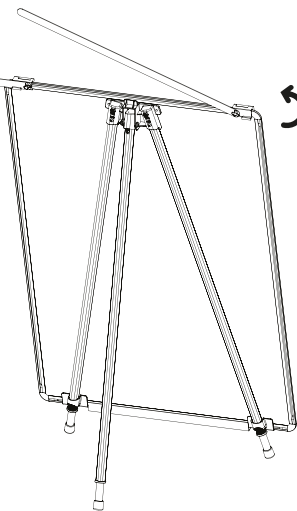

A.2x 	B.2x 	C.2x 	D.1x 	E.1x 	F.2x 	G.1x 	H.1x 	I.2x 	J.1x
K.1x 	L.1x 	M.1x 	N.1x 	O.2x 	P.1x 	Q.2x 	R.2x 	S.2x 	

WITH EXTENSIBLE ARMS

1001380290810_REV02



TRIPOD EASEL SIMPLEX CLIP ON

INSTRUCTIONS • INSTRUCTIES • ISTRUZIONI • ANLEITUNG • INSTRUCCIONES • INSTRUÇÕES

10

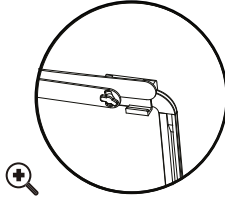
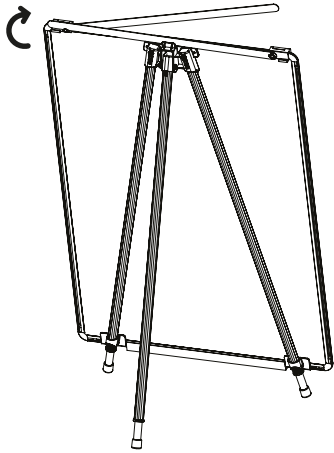

11

1xP
2xQ.
2xR.

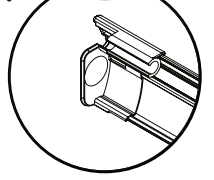
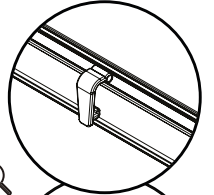
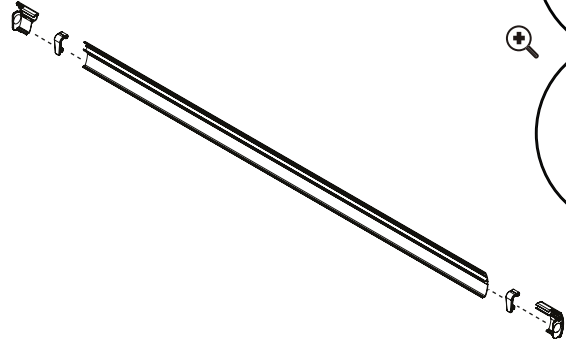

12

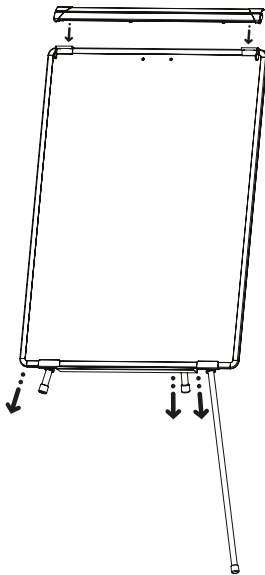

13

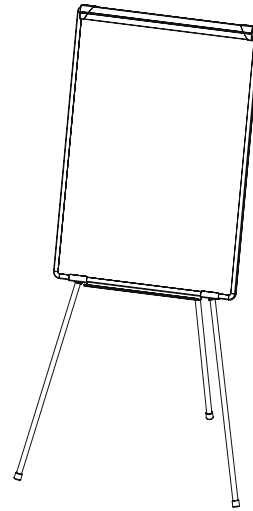
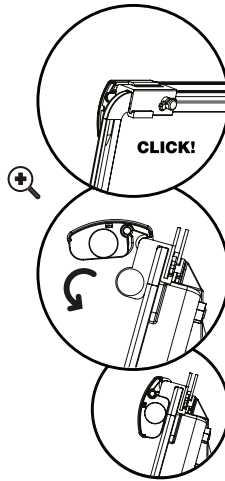

- | | | | | | | | | | |
|-----------------|-----------------|-----------------|-----------------|-----------------|-----------------|-----------------|-----------------|-----------------|-----------------|
| A.2x
 | B.2x
 | C.2x
 | D.1x
 | E.1x
 | F.2x
 | G.1x
 | H.1x
 | I.2x
 | J.1x
 |
| K.1x
 | L.1x
 | M.1x
 | N.1x
 | O.2x
 | P.1x
 | Q.2x
 | R.2x
 | S.2x
 | |

WITH EXTENSIBLE ARMS

1001380290810_REV02

